



BRIGHTTEK
BRIGHTTEK (EUROPE) LIMITED

Brighten Up The World With LED!



ISO/TS 16949:2009



BS EN ISO 14001:2004



QC 080000 IECQ HSPM

PRODUCT DATASHEET



- ▶ DC Input Photo Coupler
- ▶ SMD8 Low Profile
- ▶ Photo Transistor

TD827(SL)(T1)-GV(B)



Release Date: 13 December 2024 Version: A00



TD827(SL)(B) Series



DESCRIPTION:

The TD827(SL)(B) series provide two channel operation, and each combines an AlGaAs infrared emitting diode as the emitter which is optically coupled to a silicon planar phototransistor detector in a plastic DIP8 package with with SMD8 Low Profile lead forming option.

With the robust coplanar double mold structure, TD827(B) series provide the most stable isolation feature.

FEATURES:

- High isolation 5000 Vrms
- DC input with transistor output
- Operating temperature range -55°C to +110°C
- MSL class 1
- Regulatory Approvals:
 - UL - UL1577
 - VDE - EN60747-5-5 (VDE0884-5)
 - CQC - GB4943.1, GB8898
 - cUL - CSA Component Acceptance Service Notice 5A

APPLICATIONS:

- Computer peripheral interface
- Microprocessor system interface



Partner with: LIGHTNING

NAMING & ORDERING INFORMATION:

Naming Information:

TD827 (SL) (T1) - G V (B)	
TD827	Part Number
SL	Lead Form Option: SMD8 Low Profile
T1	Selection: Tape and Reel Option (T1(default)/T2)
G	Green Option
V	VDE Option
B	Black Housing

Ordering Information:

TD827(SL)(T1)-GV(B)						
Part Number	Symbol	Values			Unit	Test Condition
		Min.	Typ.	Max.		
TD827(SL)(T1)-GV(B)	CTR	130	---	400	%	I _F =5mA, V _{CE} =5V

Version No.	Original Release Date
Rev: A00	29/08/2024

SCHEMATIC DIAGRAM & MARKING:

Schematic Diagram:

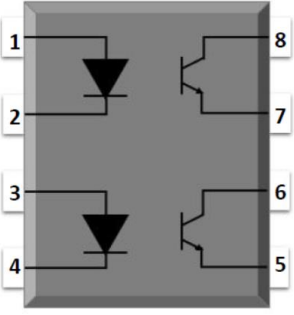
	PIN Definition	
	1	Anode
	2	Cathode
	3	Anode
	4	Cathode
	5	Emitter
	6	Collector
	7	Emitter
8	Collector	

Marking Information:

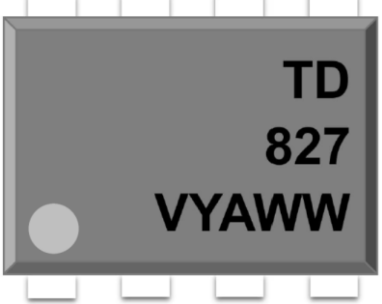
	Marking Definition	
	TD	Manufacturer Code
	827	Part Number
	V	VDE Applicable
	Y	Fiscal Year
	A	Manufacturing Code
	WW	Work Week

Labelling Information:

	<p>This product is manufactured, tested, and packed by</p> 
---	--

ABSOLUTE CHARACTERISTICS:

Absolute Maximum Ratings:

Parameter	Symbol	Ratings	Unit
INPUT			
Forward Current	I_F	60	mA
Peak Forward Current	I_{FP}	1 * ¹	A
Reverse Voltage	V_R	6	V
Input Power Dissipation	P_i	100	mW
OUTPUT			
Collector - Emitter Voltage	V_{CEO}	80	V
Emitter - Collector Voltage	V_{ECO}	6	V
Collector Current	I_c	50	mA
Output Power Dissipation	P_o	150	mW
COMMON			
Total Power Dissipation	P_{tot}	200	mW
Isolation Voltage	V_{iso}	5000 * ²	V _{rms}
Operating Temperature	T_{opr}	-55~+110	°C
Storage Temperature	T_{stg}	-55~+125	°C
Soldering Temperature	T_{sol}	260 * ³	°C

*1. 100µs pulse, 100Hz frequency

*2. AC for 1 minute, R.H.=40~60%

*3. For 10 seconds max.

ELECTRICAL CHARACTERISTICS:

Electrical Optical Characteristics at Ta=25°C:

Parameter	Symbol	Values			Unit	Test Condition	
		Min.	Typ.	Max.			
INPUT							
Forward Voltage	V _F	---	1.24	1.4	V	I _F =10mA	
Reverse Current	I _R	---	---	10	μA	V _R =6V	
Input Capacitance	C _{IN}	---	10	---	pF	V=0, f=1kHz	
OUTPUT							
Collector Dark Current	I _{CEO}	---	---	100	nA	I _F =0mA, V _{CE} =20V	
Collector - Emitter Breakdown Voltage	BV _{CEO}	80	---	---	V	I _C =0.1mA, I _F =0mA	
Emitter - Collector Breakdown Voltage	BV _{ECO}	6	---	---	V	I _E =0.1mA, I _F =0mA	
TRANSFER CHARACTERISTICS							
Current Transfer Rate	TD827	CTR	130	---	400	%	I _F =5mA, V _{CE} =5V
Collector-Emitter Saturation Voltage		V _{CE(sat)}	---	0.06	0.2	V	I _F =20mA, I _C =1mA
Isolation Resistance		R _{ISO}	10 ¹²	10 ¹⁴	---	Ω	DC=500V, 40~60% R.H.
Floating Capacitance		C _{IO}	---	0.4	1	pF	V=0, f=1MHz
Response Time (Rise)		t _r	---	3	18	μs	V _{CE} =2V, I _C =2mA R _L =100Ω
Response Time (Fall)		t _f	---	4	18	μs	
Cut-off Frequency		f _c	---	80	---	kHz	V _{CE} =2V, I _C =2mA R _L =100Ω, -3dB

CHARACTERISTIC CURVES:

Forward Current v.s. Ambient Temperature

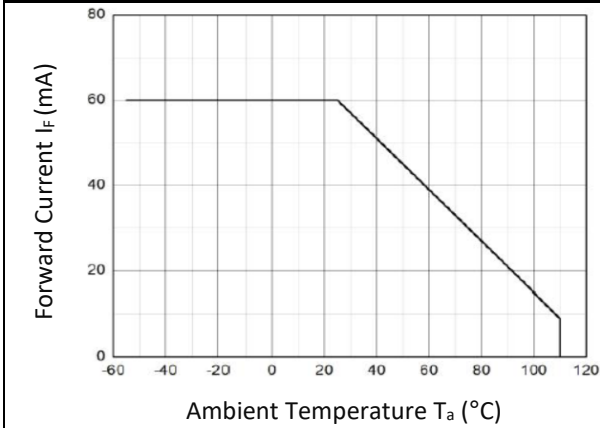

Collector Power Dissipation v.s. Ambient Temp.

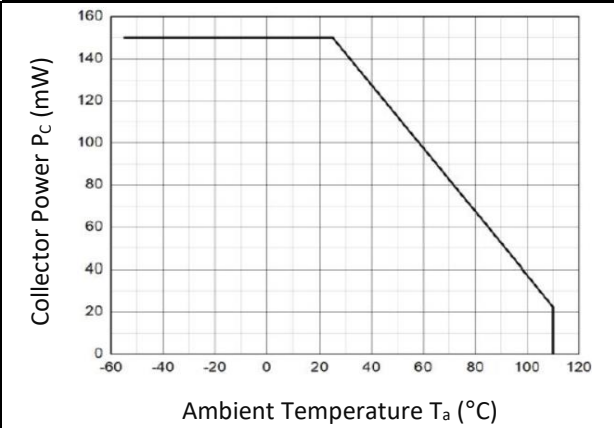

Forward Current v.s. Forward Voltage

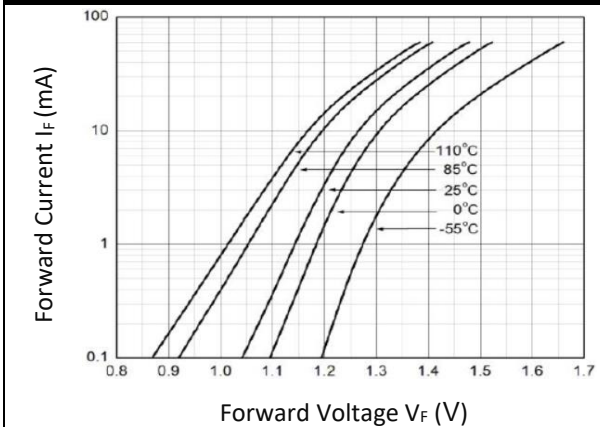

Collector Dark Current v.s. Ambient Temperature

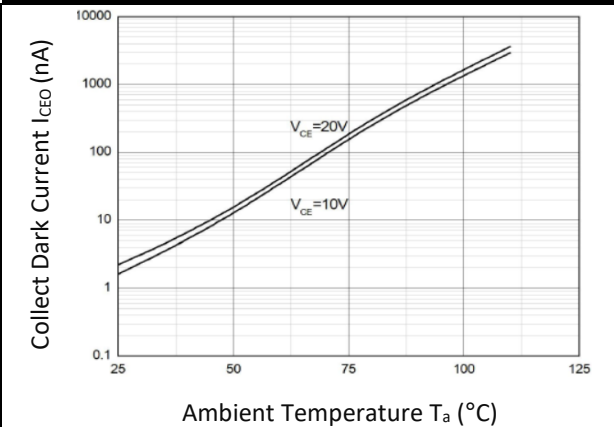

Collector Current v.s. Collector-Emitter Voltage

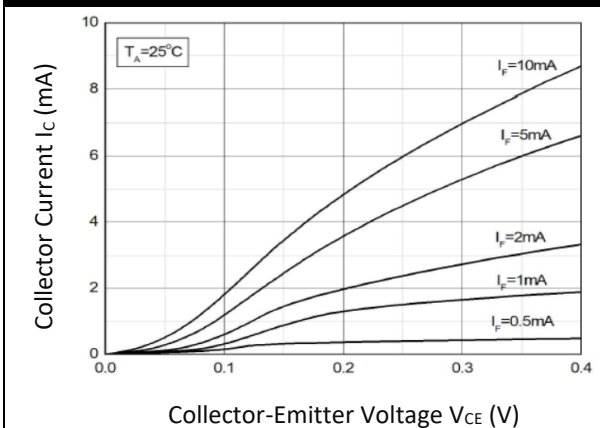

Collector Current v.s. Collector-Emitter Voltage

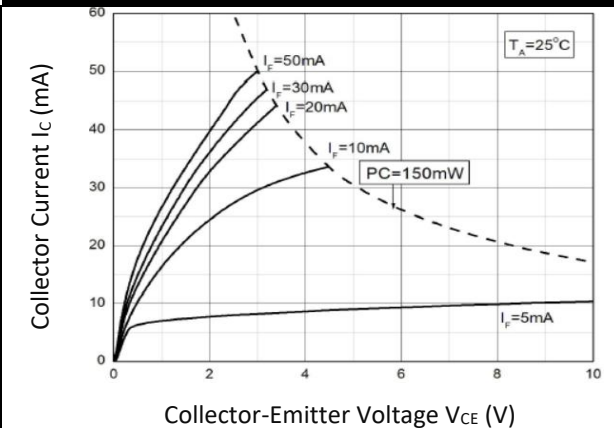

CHARACTERISTIC CURVES:

Normalized Current Transfer Ratio v.s. Forward Current

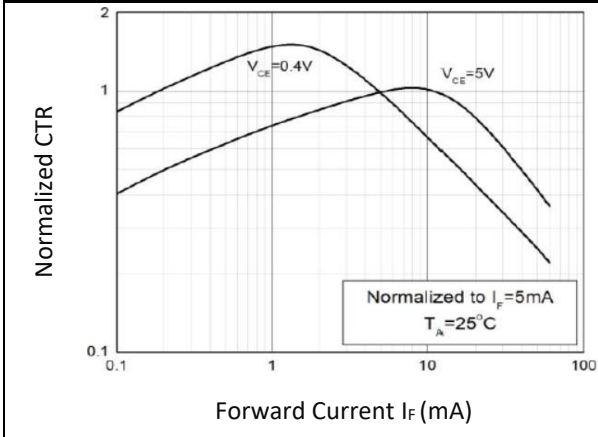

Normalized Current Transfer Ratio v.s. Ambient Temperature

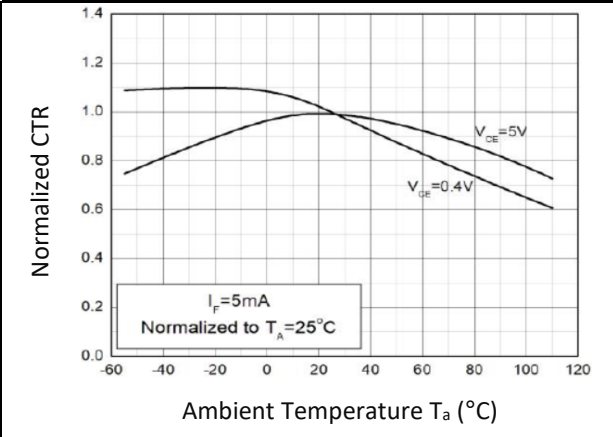

Collector-Emitter Saturation Voltage v.s. Ambient Temperature

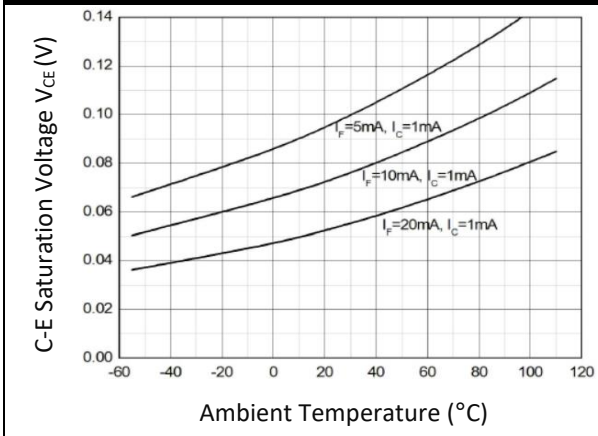

Switching Time v.s. Load Resistance

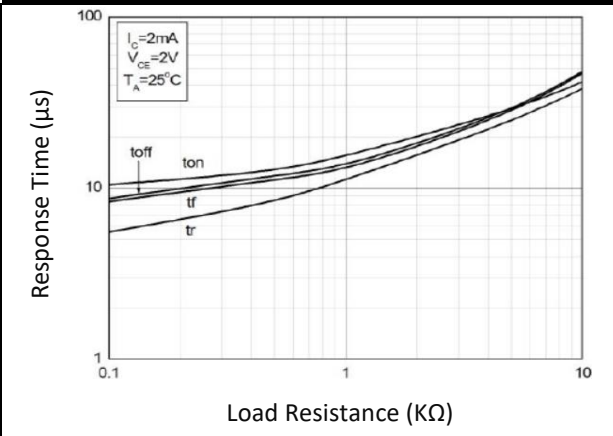

Frequency Response

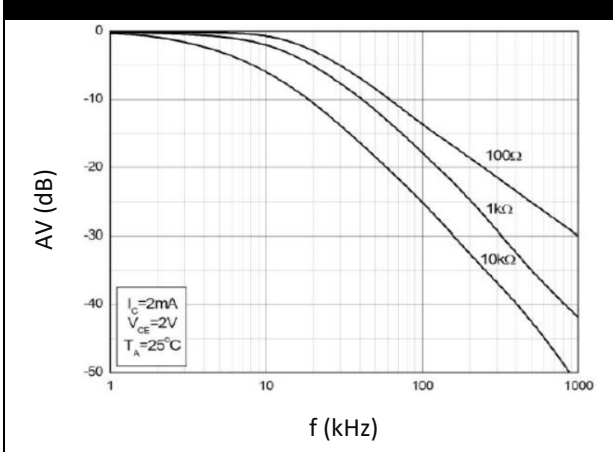

TEST CIRCUIT:

Test Circuit of Response Time:

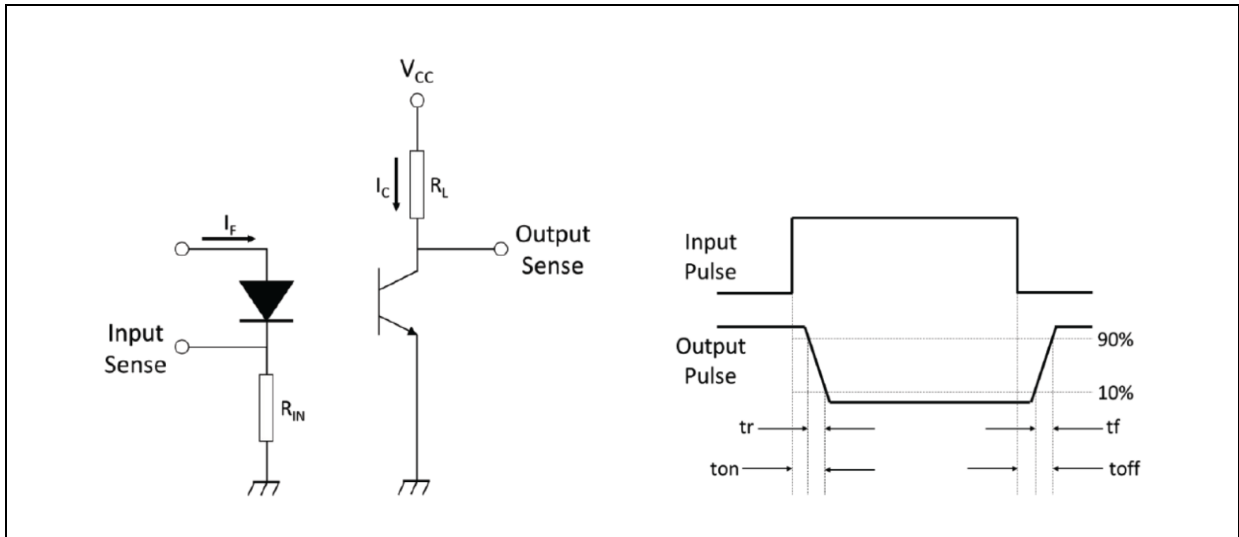

Test Circuit of Frequency Response:

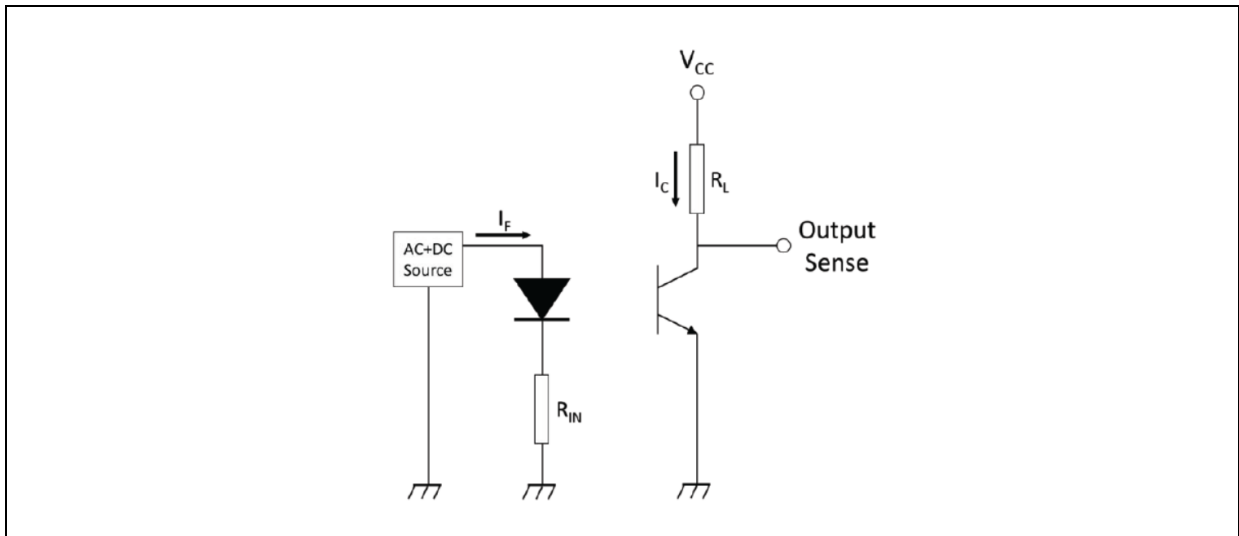

OUTLINE DIMENSION:

Package Dimension:

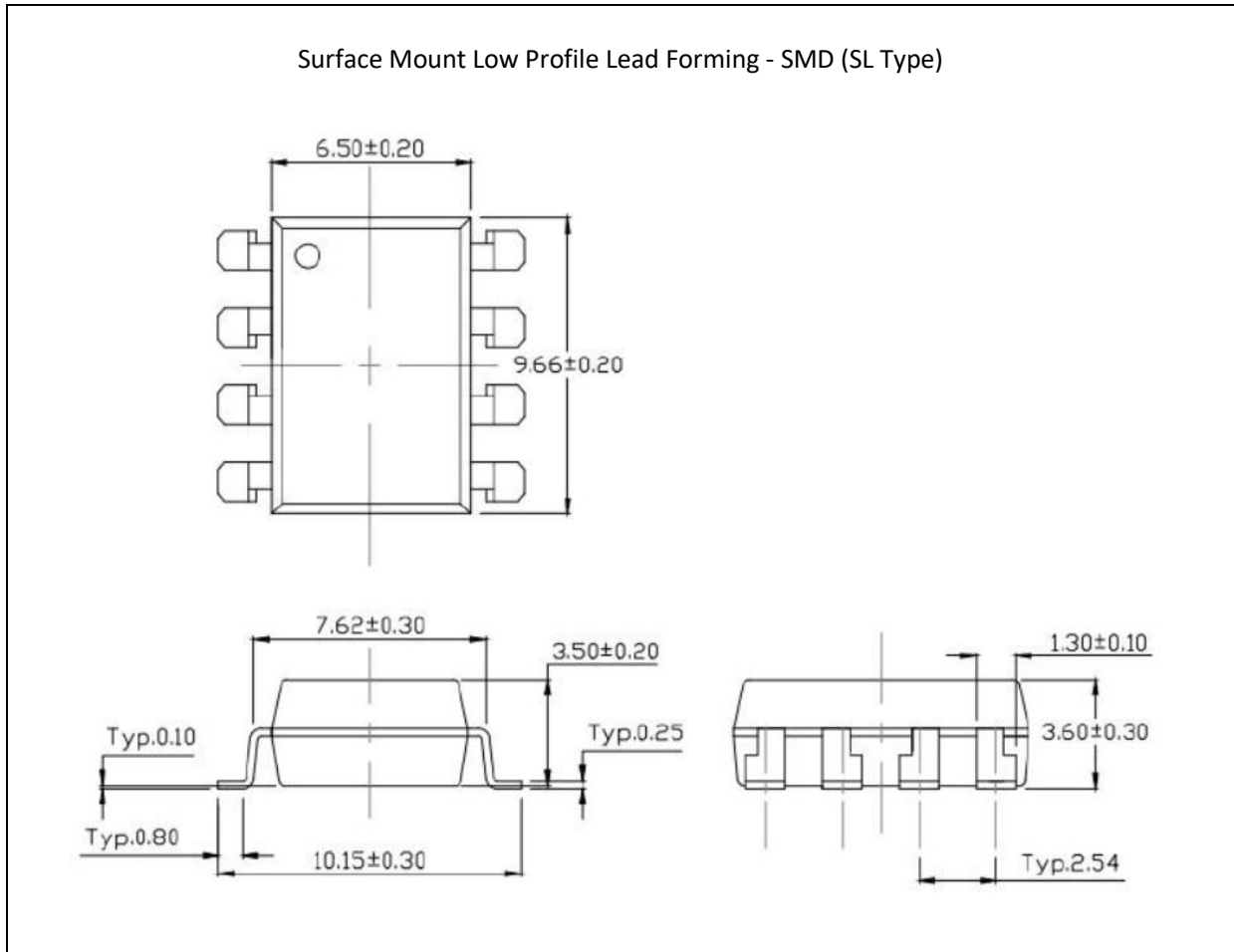

- All dimensions are in millimetre (mm).

Recommended Soldering Mask:

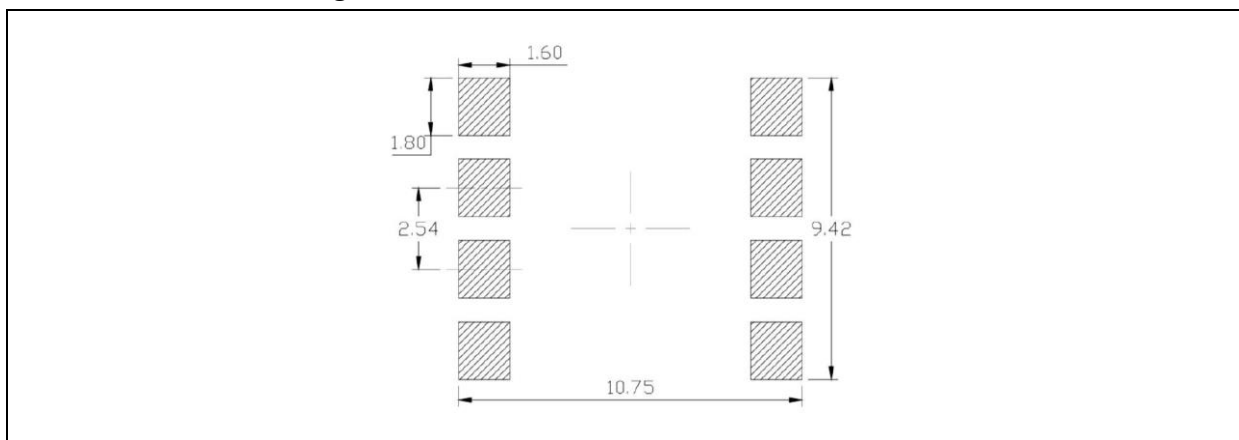

- Dimensions are in millimetre (mm).

PACKING SPECIFICATION:

Reel Dimension:

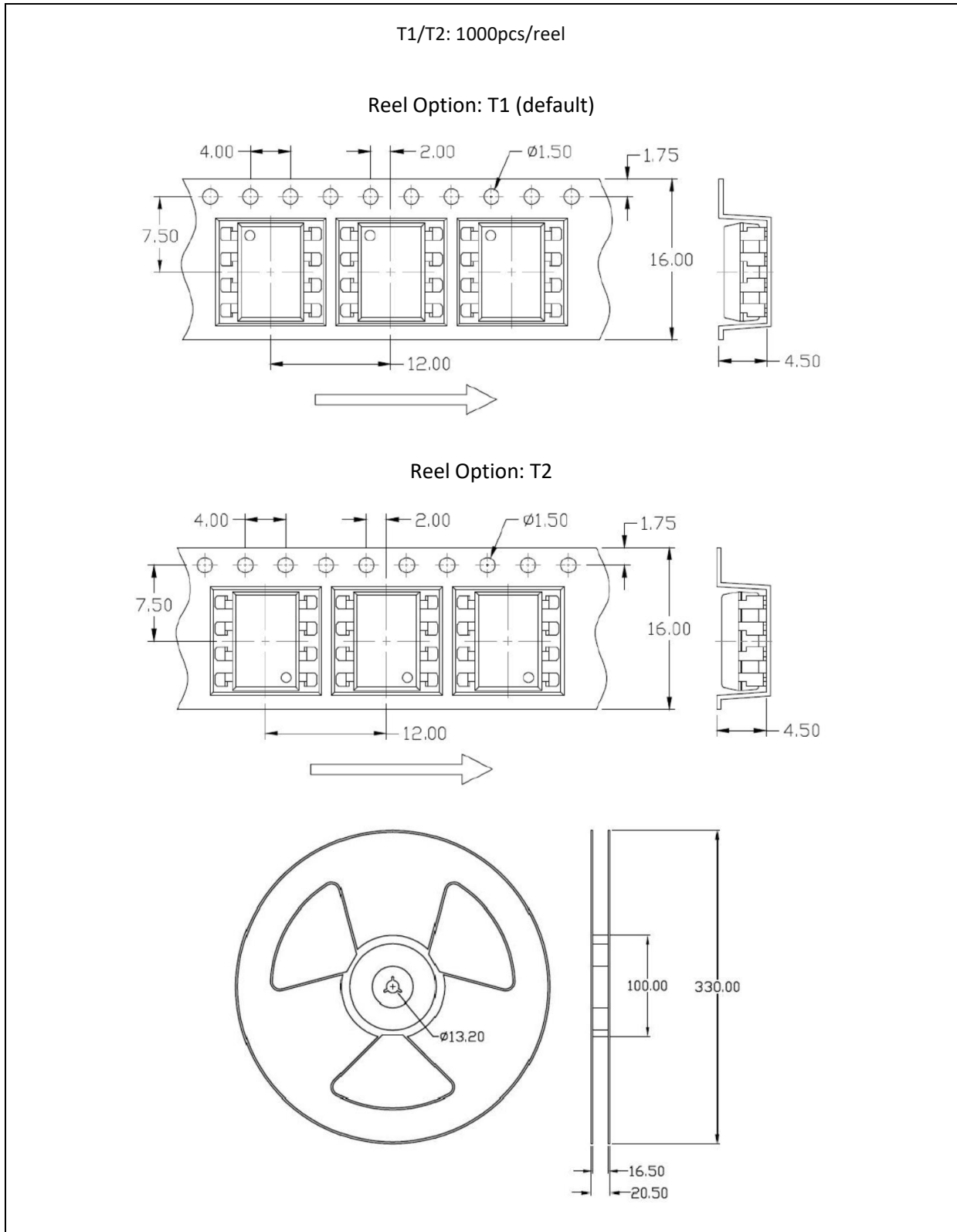

Box Dimension:

T1/T2: 3 reels (3Kpcs)/inner box, 5 inner boxes (15Kpcs)/carton

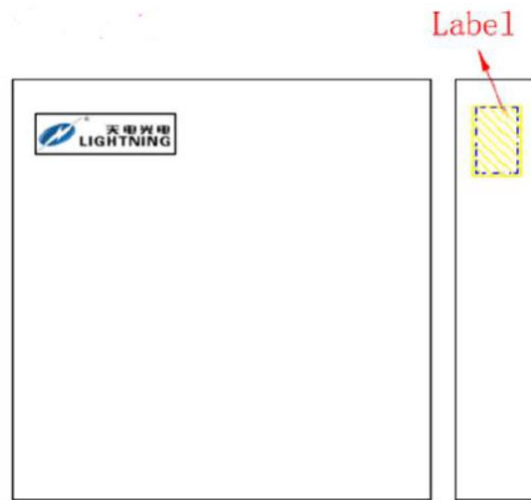

- L x W x H = 36cm x 36cm x 6.9cm

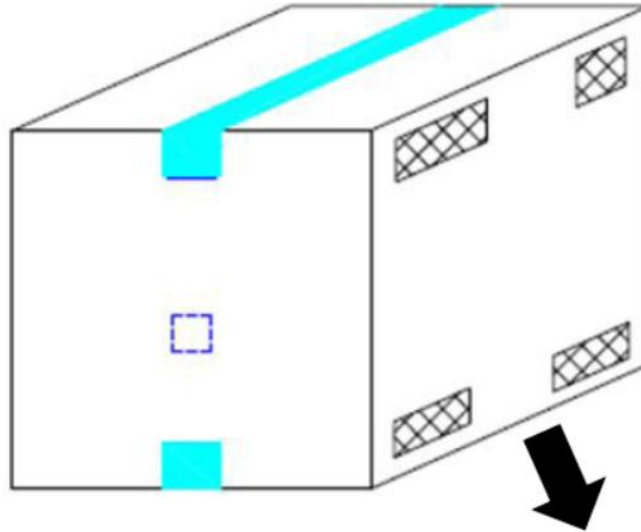

- L x W x H = 45cm x 38cm x 38cm

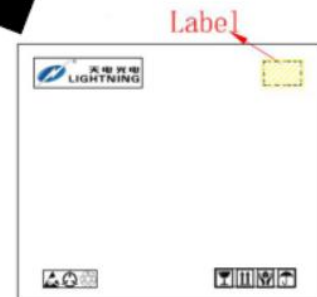

RECOMMENDED SOLDERING PROFILE:

Reflow Information:

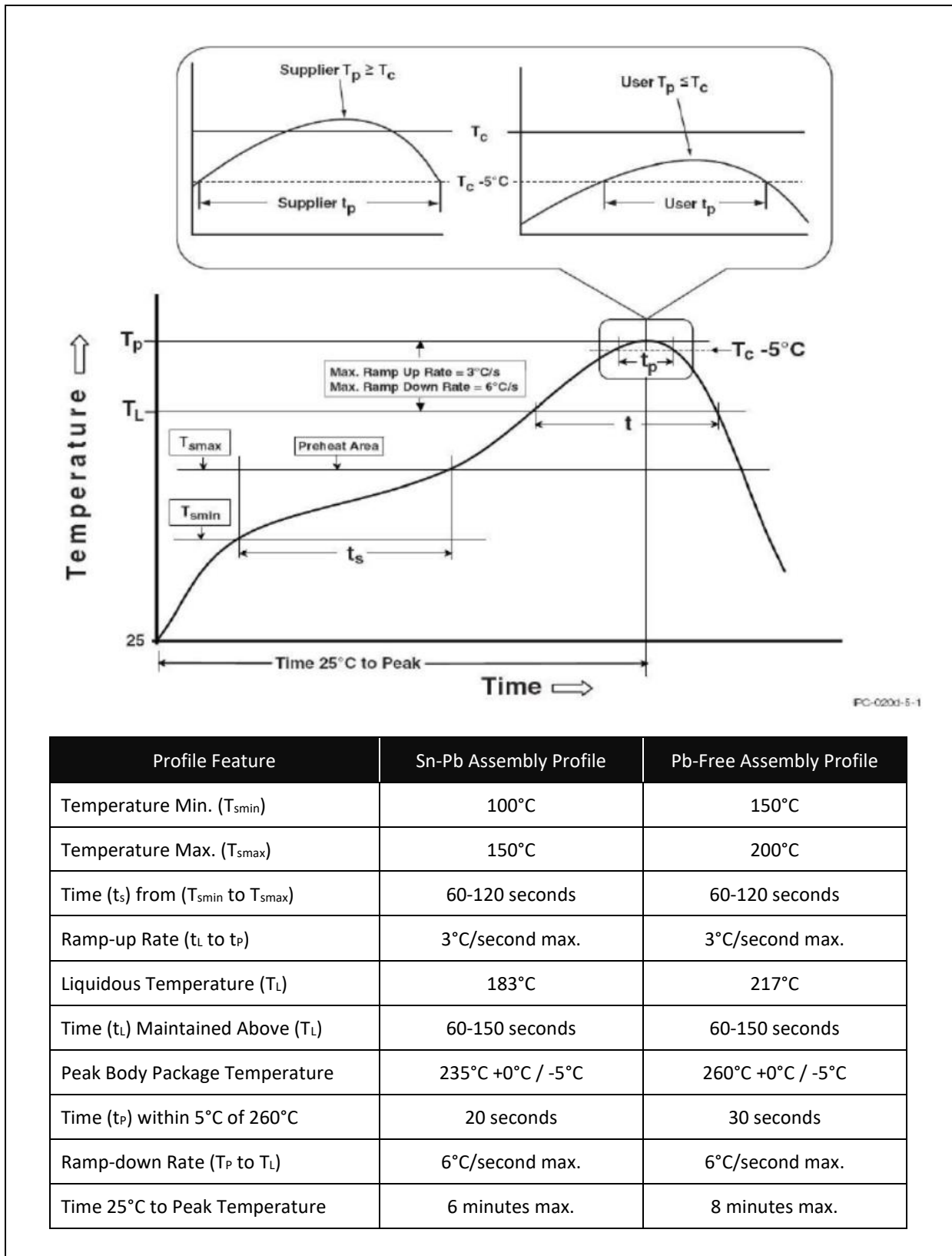

Wave Soldering (JESD22-A111 Compliant):

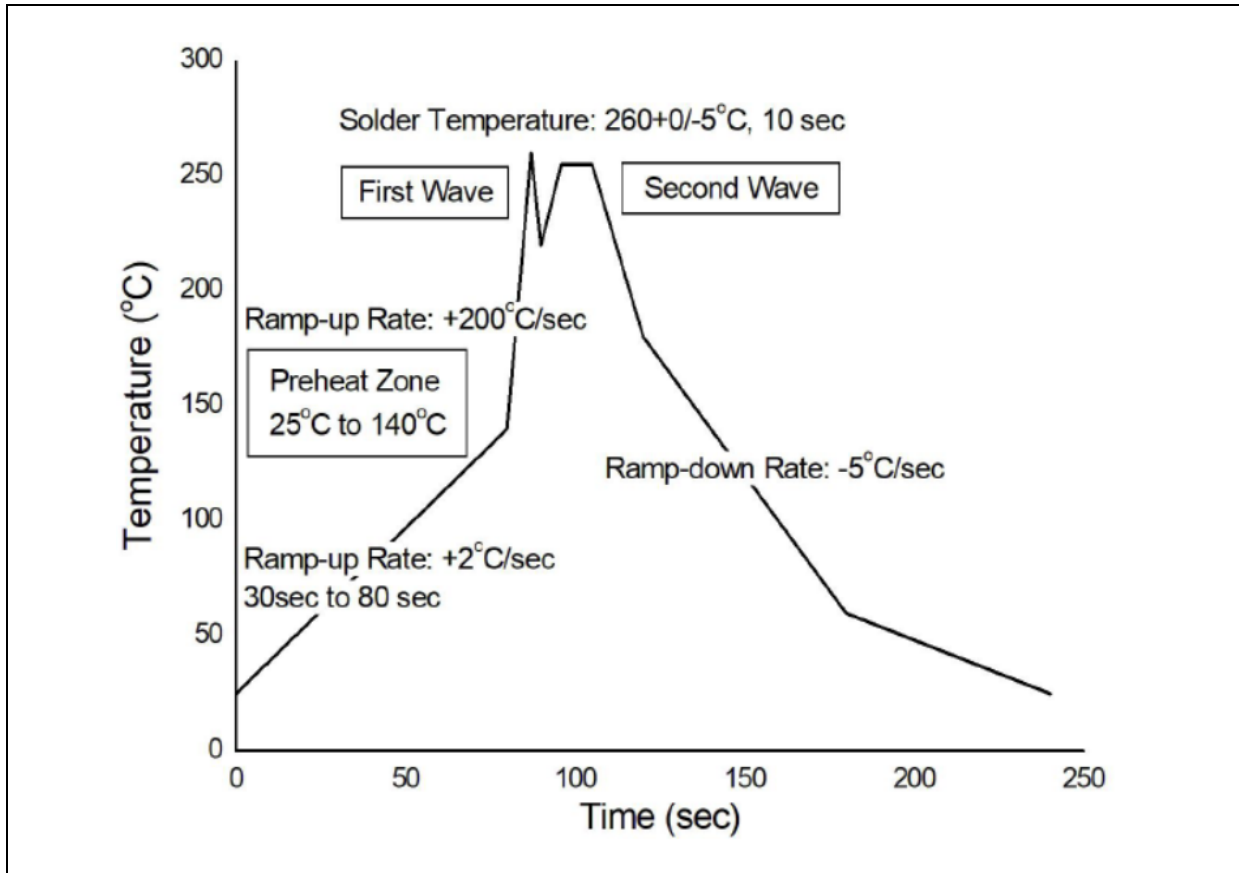

Hand Soldering:

Soldering Temperature	$380 \pm 5^{\circ}\text{C}$
Soldering Time	3 sec max.

Note:

- One time soldering is recommended for all soldering methods.
- Do not solder more than three times for IR reflow soldering.