



BRIGHTTEK
BRIGHTTEK (EUROPE) LIMITED

Brighten up The World With LED!



ISO/TS 16949:2009



BS EN ISO 14001:2004



QC 080000 IECQ HSPM

PRODUCT DATASHEET



- ▶ DC Input Photo Coupler
- ▶ SMD6 Low Profile
- ▶ Schmitt Trigger

H11LX(SL)(T1)-GV



Release Date: 30 August 2024 Version: A00



H11LX(SL) Series



DESCRIPTION:

The H11LX(SL) series combine an AlGaAs infrared emitting diode as the emitter which is optically coupled to a Schmitt Trigger detector in a plastic DIP6 package with SMD6 Low Profile lead forming option.

FEATURES:

- High isolation 5000 Vrms
- DC input with Schmitt Trigger output
- Operating temperature range -55°C to +100°C
- REACH & RoHS compliance
- MSL class 1
- Regulatory Approvals:
 - UL - UL1577
 - VDE - EN60747-5-5 (VDE0884-5)
 - CQC - GB4943.1, GB8898
 - cUL - CSA Component Acceptance Service Notice 5A
- Packing: 16mm tape with 1000pcs/reel, ø330mm (13'')

APPLICATIONS:

- Logic to logic isolator
- Programmable current level sensor
- Line receiver - eliminate noise and transient problems
- AC to TTL conversion square wave shaping
- Power Supply digital programming
- Interfaces computer peripherals



Partner with: LIGHTNING

NAMING & ORDERING INFORMATION:

Naming Information:

H11L X (SL) (T1) - G V	
H11L	Part Number
X	Selection: Turn On Threshold Current (X=1/2/3)
SL	Lead Form Option: SMD6 Low Profile
T1	Selection: Tape and Reel Option (T1(default)/T2)
G	Green Option
V	VDE Option

Ordering Information:

H11LX(SL)(T1)-GV						
\underline{X} = Selection: Turn On Threshold Current (X=1/2/3)						
Part Number	Symbol	Values			Unit	Test Condition
		Min.	Typ.	Max.		
H11L1(SL)(T1)-GV	I _{Fon}	---	---	1.6	mA	V _{CC} =5V, R _L =270Ω
H11L2(SL)(T1)-GV		---	---	10		
H11L3(SL)(T1)-GV		---	---	5		

Version No.	Original Release Date
Rev: A00	22/06/2021

SCHEMATIC DIAGRAM & MARKING:

Schematic Diagram:

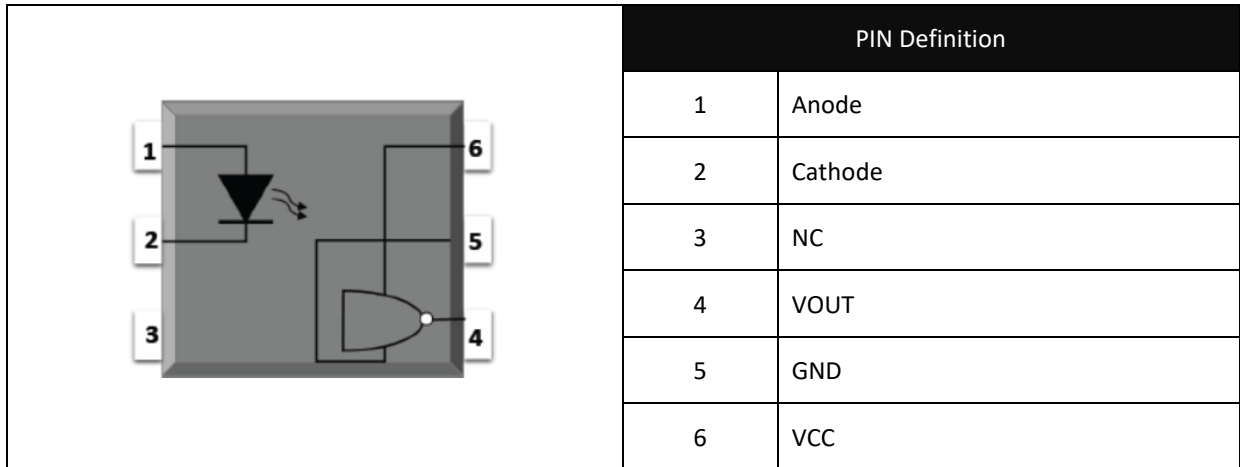

Marking Information:

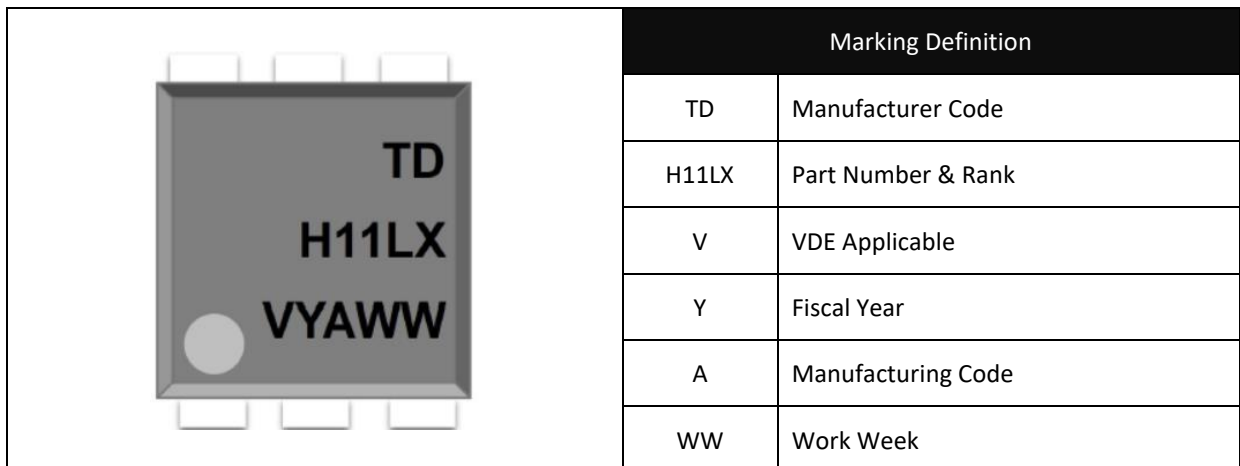

Labelling Information:

	<p>This product is manufactured, tested, and packed by</p>
	

ABSOLUTE CHARACTERISTICS:

Absolute Maximum Ratings:

Parameter	Symbol	Ratings	Unit
INPUT			
Forward Current	I_F	60	mA
Peak Transient Current	$I_{F(trans)}$	1 * ¹	A
Reverse Voltage	V_R	6	V
Input Power Dissipation	P_i	120	mW
OUTPUT			
Supply Voltage	V_{CC}	3 to 16	V
Output Voltage	V_O	0 to 16	V
Output Current	I_o	50	mA
Output Power Dissipation	P_o	150	mW
COMMON			
Total Power Dissipation	P_{tot}	250	mW
Isolation Voltage	V_{iso}	5000 * ²	V _{rms}
Operating Temperature	T_{opr}	-55~+100	°C
Storage Temperature	T_{stg}	-55~+150	°C
Soldering Temperature	T_{sol}	260 * ³	°C

*1. $\leq 1\mu s$ P.W., 300pps

*2. AC for 1 minute, R.H.=40~60%

*3. For 10 seconds

ELECTRICAL CHARACTERISTICS:

Electrical Optical Characteristics at Ta=25°C:

Parameter	Symbol	Values			Unit	Test Condition
		Min.	Typ.	Max.		
INPUT						
Forward Voltage	V _F	---	1.24	1.5	V	I _F =10mA
Reverse Current	I _R	---	---	10	μA	V _R =5V
Input Capacitance	C _{IN}	---	60	---	pF	V=0, f=1MHz
OUTPUT						
Operation Voltage Range	V _{CC}	3	---	15	V	---
Off State Supply Current	I _{CC(off)}	---	1.6	5	mA	I _F =0mA, V _{CC} =5V
On State Supply Current	I _{CC(on)}	---	1.6	5	mA	I _F =10mA, V _{CC} =5V
High Level Output Current	I _{OH}	---	---	100	μA	I _F =10mA, V _{CC} =V _O =15V
TRANSFER CHARACTERISTICS (Ta=-40~+85°C)						
Low Level Output Voltage	V _{OL}	---	0.35	0.6	V	V _{CC} =5.5V, V _E =2.0V I _F =5mA, I _{CL} =13mA
Turn On Threshold Current	H11L1	I _{Fon}	---	---	1.6	mA V _{CC} =5V, R _L =270Ω
	H11L2		---	---	10	
	H11L3		---	---	5	
Turn Off Threshold Current	I _{Foff}	---	1	---	mA	V _{CC} =5V, R _L =270Ω
Turn On Time	t _{on}	---	---	4	μs	V _{CC} =5V, I _F =I _{Fon} , R _L =270Ω
Fall Time	t _f	---	0.1	---	μs	
Turn Off Time	t _{off}	---	---	4	μs	
Rise Time	t _r	---	0.1	---	μs	
Data Rate	---	---	1	---	MHz	---
Isolation Resistance	R _{iso}	10 ¹²	10 ¹⁴	---	Ω	DC=500V, 40~60% R.H.
Floating Capacitance	C _{IO}	---	0.3	1	pF	V=0, f=1MHz

CHARACTERISTIC CURVES:

Forward Voltage v.s. Forward Current

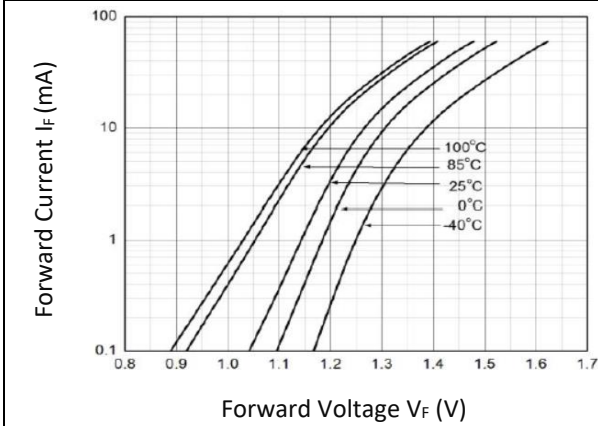

Output Voltage v.s. Forward Current

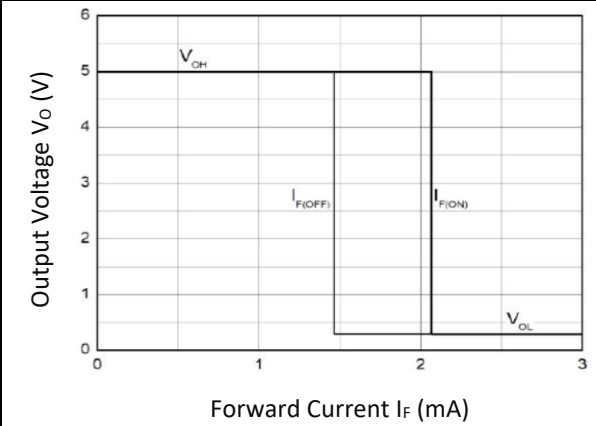

Normalized Turn-On Threshold Current v.s. Supply Voltage

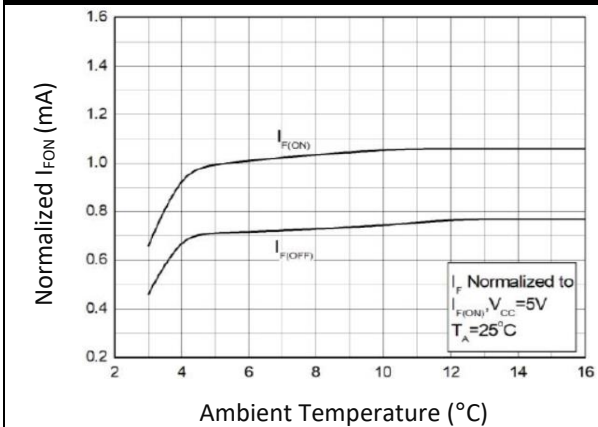

Normalized Turn-On Threshold Current v.s. Ambient Temperature

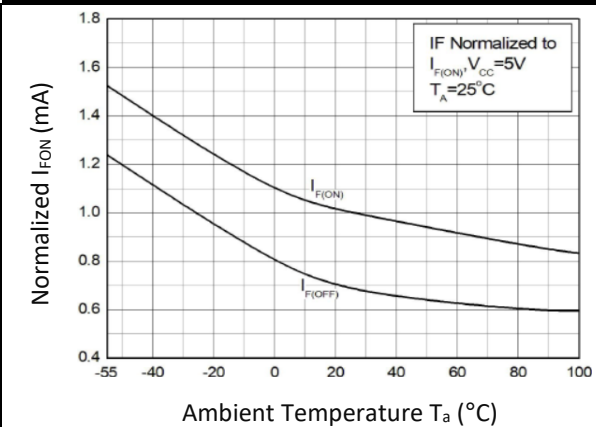

Low Level Output Voltage v.s. Load Current

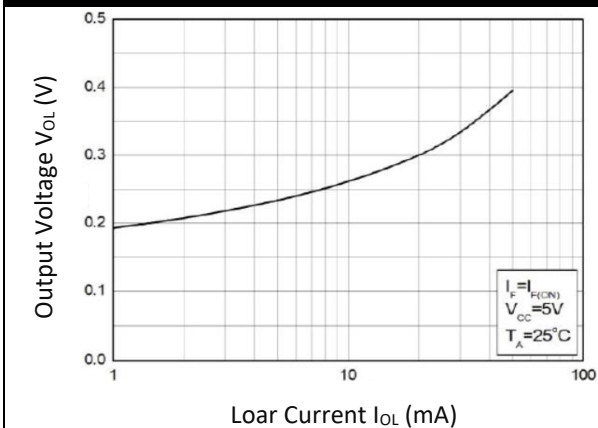

Supply Current v.s. Supply Voltage

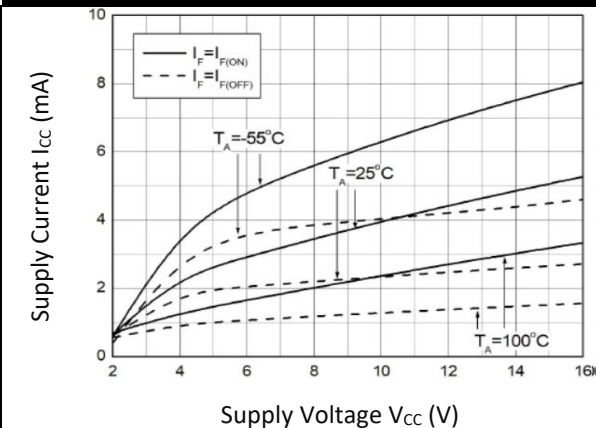

OUTLINE DIMENSION:

Package Dimension:

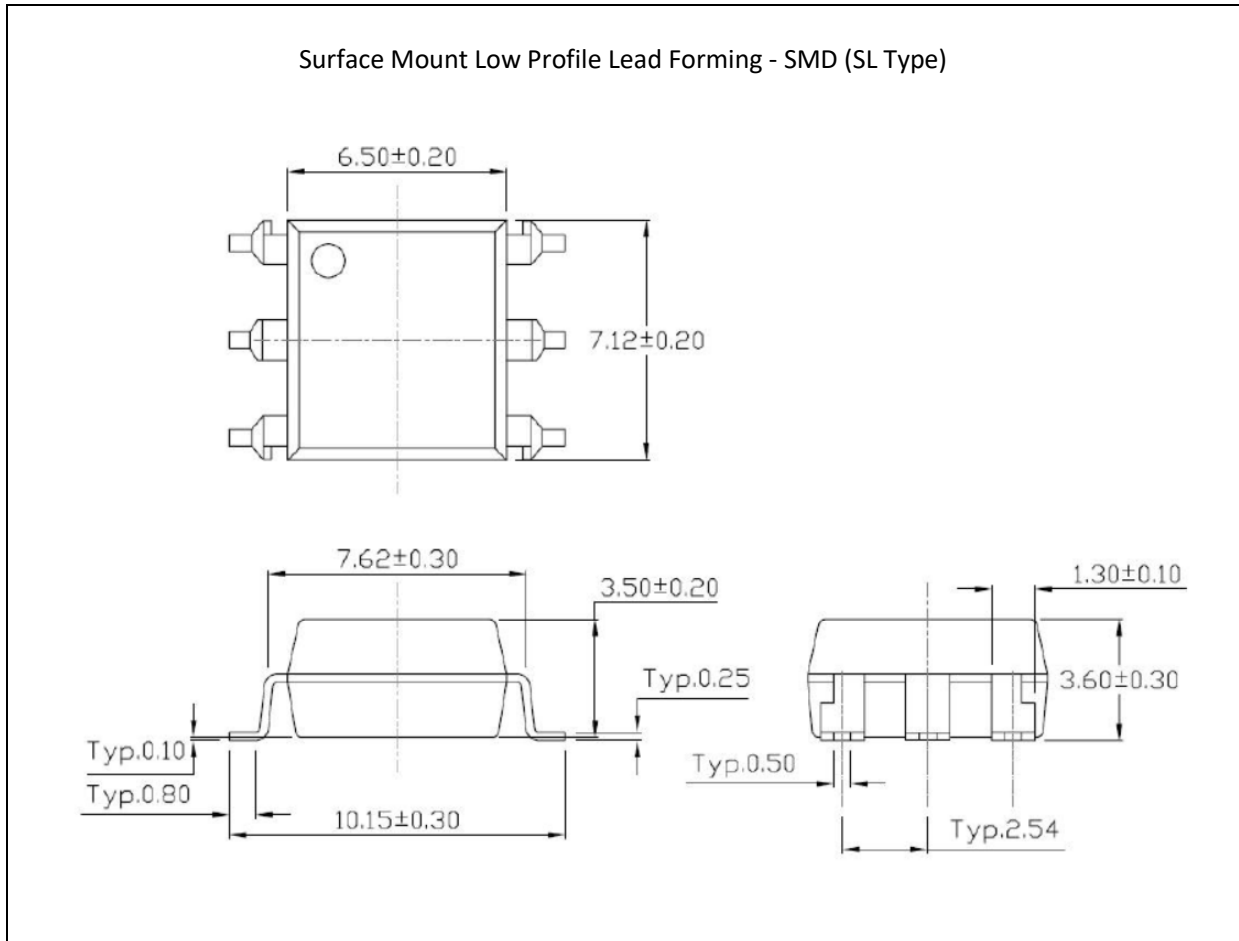

1. All dimensions are in millimetre (mm).

Recommended Soldering Mask:

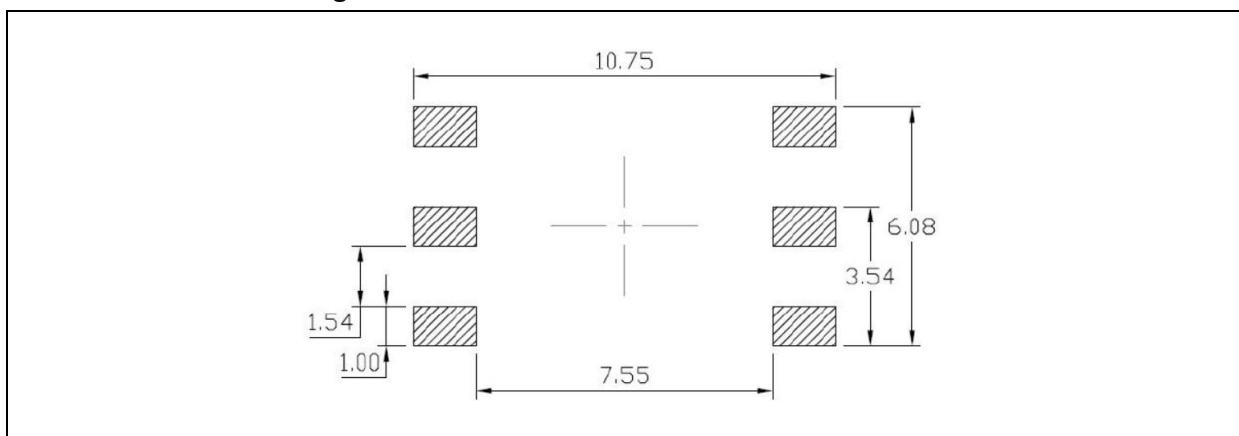

1. Dimensions are in millimetre (mm).

PACKING SPECIFICATION:

Reel Dimension:

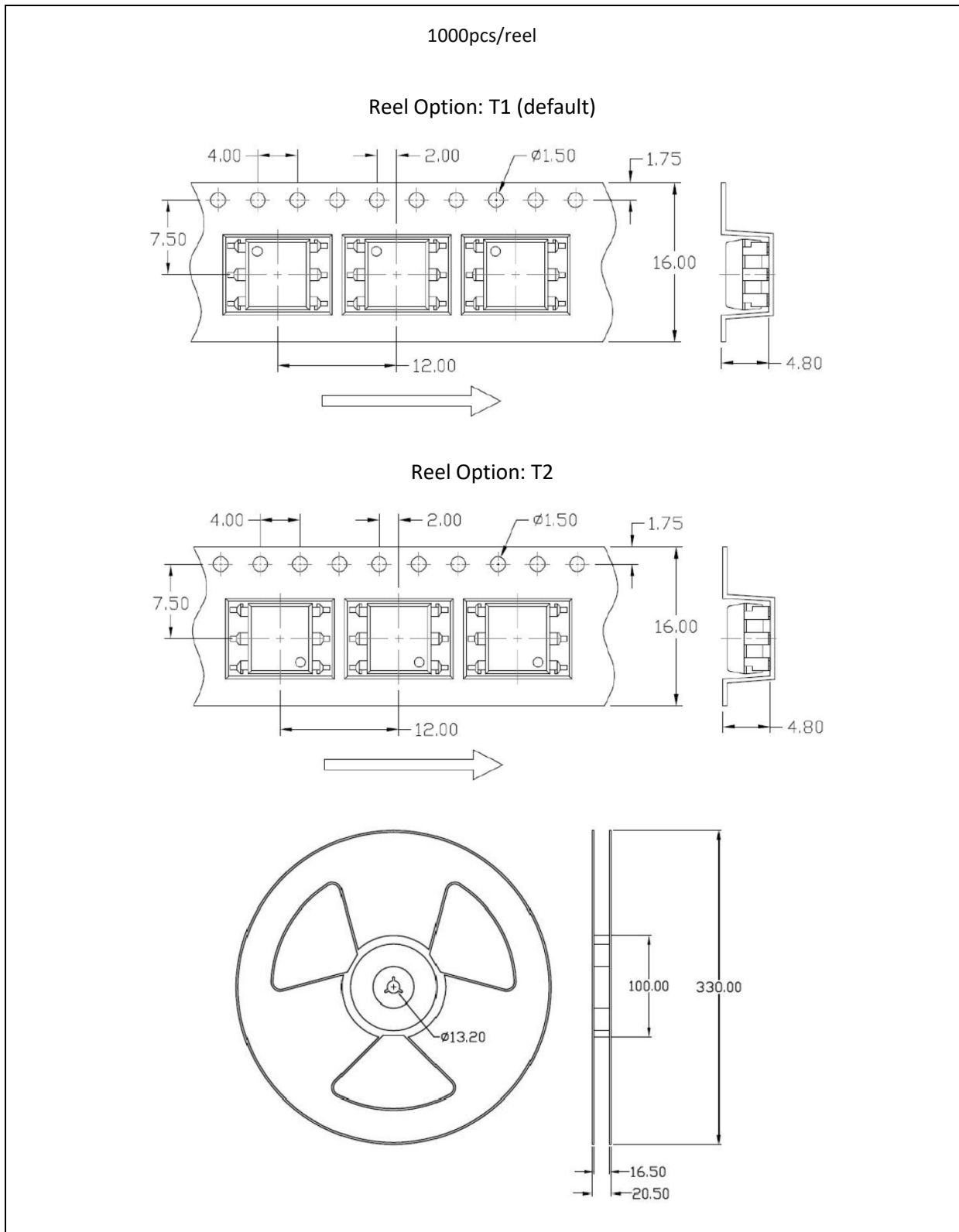

PACKING SPECIFICATION:

Box Dimension:

3 reel (3Kpcs)/inner box, 5 inner box (15Kpcs)/carton

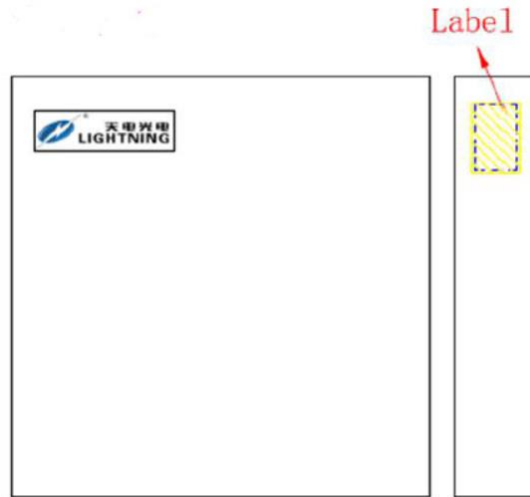

- L x W x H = 36cm x 36cm x 6.9cm

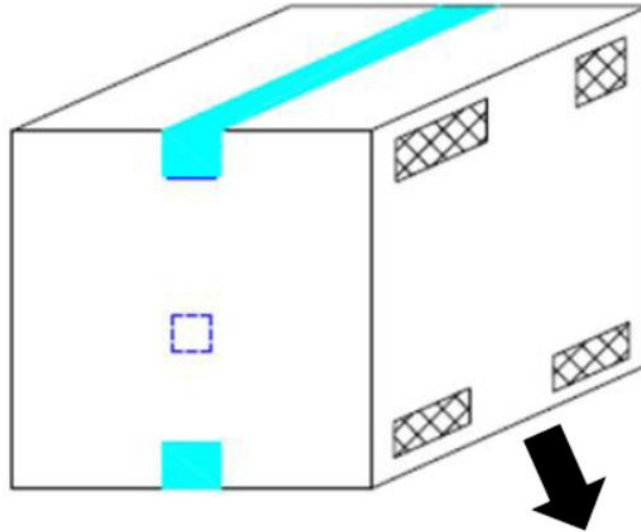

- L x W x H = 45cm x 38cm x 38cm

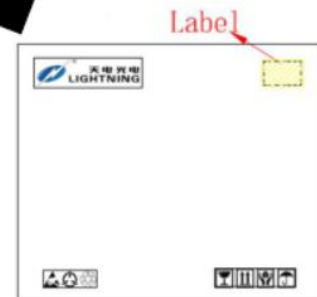

RECOMMENDED SOLDERING PROFILE:

Reflow Information:

